

WOLF Composite Decking Installation Instructions

For TC-G (TC-150) for use with 1" (25mm) or thicker decking

WOLF
COMPOSITE DECKING
Real performance. Real value.

Tiger Claw[®]
Hidden Deck Fasteners
153 Bowles Road • Agawam, MA 01001

GETTING STARTED / INSTALLATION TIPS

IMPORTANT! Read all instructions carefully and completely to ensure proper installation.

WARNING! Parts have sharp points & edges. Use extreme caution when handling & installing. Wear safety glasses at all times.

Tools & Materials Needed



Safety Glasses



Power screw gun with ratcheting torque setting

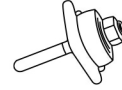

Tiger Claw Slot Cutter



Router

Step 1

INSTALL FIRST BOARD

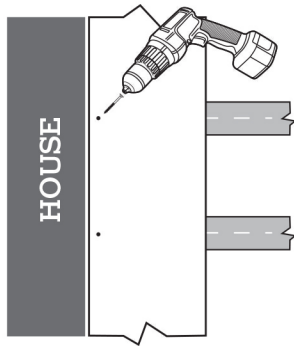

Fasten one edge of the first board at each framing support using a quality 2½" (64mm) deck screw. It is important that this board is straight and well secured.

Step 3

INSTALL FIRST FASTENER

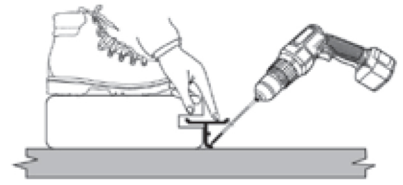

While standing on deck board, install provided screw at 45° angle through fastener and into joist, while applying pressure on fastener. Install one fastener and screw at each support joist.

Make sure fastener body is vertical to deck board and the screw is holding fastener down tight to support joist. Adjust torque setting on screw gun to prevent spin out of the screw head.

Step 2

POSITION FASTENERS

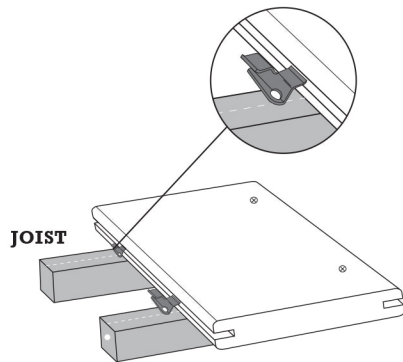

Fully insert TC-G fastener into grooved edge of deck board. Screw hole should line up with the center of support joist.

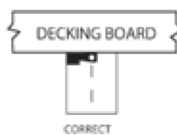
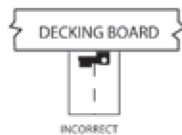

Step 4

COMPLETING INSTALLATION OF BOARDS

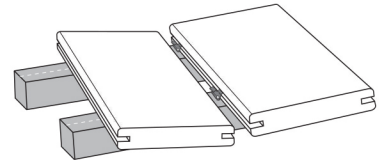

a Place next deck board into position against fasteners. Slightly raise outer edge of board being installed and slide board onto fastener until board contacts spacer tabs.

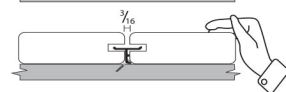

b Check gap between boards for consistency. Apply force to ensure board is fully installed.

Repeat steps 2 thru 4 until deck is complete.

HELPFUL TIPS

Coverage

- Multiply the number of joists by the number of decking boards to equal the number of fasteners needed.
- 90 fasteners will cover approximately 50 sq. ft. (4.6 m) using 5.5" (140mm) decking boards on 16" (410mm) centers or 35 sq. ft. (3.3 m) using 3.5" (90mm) decking boards on 16" (410mm) on centers.

How do you attach the last board?

To finish, we recommend using either finish nails or trim screws to secure the last board along its edge. Or, you can angle a screw through the deck frame and into the bottom of the deck board.

45° angle installation

When deck is in the walled corner of the house: always start with small piece of decking in that corner and work your way out. **When installing TC Fasteners,** offset the center $\frac{1}{8}$ " (13mm) towards the long point of joist, so screw will not exit side of joist when driven.

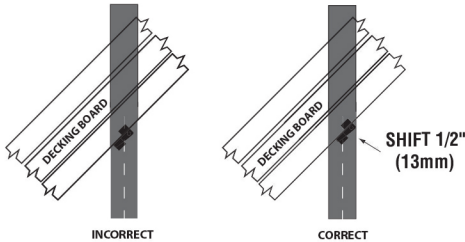

How to do a butt seam

For TC-G (TC-150): Butt Seam clip is available to use with the TC-G (TC-150)

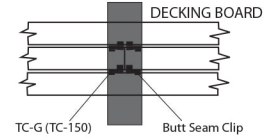

How to replace a board

- Make two parallel cuts down the center of the board to be replaced, and remove the center piece.
- Using a small pry bar, remove the remaining pieces of decking from the tabs.
- Using a reciprocating saw, remove the tabs on the side of the board with the screw heads showing.
- Position new board into place, and carefully slide onto remaining tabs.
- Once board is set into position, secure the lead edge with finish nail, finish screw, or counter drill, screw and plug.

To use the TC-G fastener on solid-edge boards Use a router to create a groove at every intersection of the deck board and support joists, or groove the entire edge of the deck board.



For TC-G (for use in 1" (25mm) or thicker decking: Use the Tiger Claw TC-G Slot Cutter to create the groove shown below.

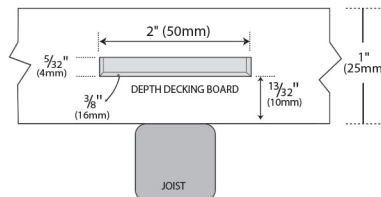

NOTE: The groove should start $\frac{13}{32}$ " (10mm) above the **BOTTOM** of the deck board. Groove should be at least $\frac{7}{16}$ " (11mm) deep.

NOTE: When using material with expected expansion greater than $\frac{1}{8}$ " (3mm), in width allow additional spacing between deck boards. (Check with your lumber supplier for expected expansion in your area.)

Tiger Claw[®]
Hidden Deck Fasteners
153 Bowles Road • Agawam, MA 01001

Email: tigerclaw@deckfastener.com
Tech Support: 800-518-3569 toll free
Customer Service: 800-518-3569 toll free
Fax: 413-786-1760



For more information, please contact your WOLF Sales Consultant or WOLF Customer Service at 1.877.315.6669
WWW.WOLFHOMEPRODUCTS.COM